

SPECIFICATION
FOR
SWITCHING POWER SUPPLY

M/N: MPM-U655

Revision History

Version	Date	Change Items
Rev. 01	Oct.27. 2017	Established.
Rev. 02	May.2. 2018	Changed model name to MPM-U655-D00-B.
Rev. 03	Jul.13. 2018	Changed EMC Dips and Interruptions.
Rev. 04	Sep.10. 2018	Deleted Notes & Conditions of MC: Emissions.
Rev. 05	Sep.26. 2018	1.Changed model name to MPM-U655. 2.Changed Notes & Conditions of MC: Emissions. 3.Added +5VSB, REMOTE, PG / PF in the "FEATURES". 4.Changed Power Fail Signal. 5.Add Optional-Modules and changed Model no. coding. 6. Changed Mechanical diagram.



FEATURES

- ✓ Configurable Power Supply.
- ✓ 650W medical power supply with force air cooling. Peak power up to of 750W.
- ✓ Optional digital function to read PSU data by USB connector.
- ✓ IP to OP 2xMOPP; IP to Earth 1xMOPP.
- ✓ Automatically fan speed control to reduce the noise.
- ✓ Built in -12V & +5V stand by with reduce ON/OFF function.
- ✓ PG / PF signal.

Models & Ratings

Model Number	Wattage (Rated / Peak)	Output Voltage		Min. Current	Rated Current	Peak. Current
MPM-U655	650 W / 750 W	V1	+24 V	0 A	27.1 A	31.3 A
		V2	+5.1 Vsb	0 A	2 A	----
		V3	-12 V	0 A	0.2 A	----

Note:

1. Open frame type can be 450W(AC115V) at 50°C convection cooled environment.
2. Peak duration is 1,000 ms max, input voltage must exceed 100VAC.
3. Initial setting voltage is at input 115VAC and all outputs at 60% rated load.
4. Capacity of configurable slots: 2 slots.
5. For model number coding, refer to page 4.

Optional-Modules

Voltage	Maximum Current	Maximum Power	Slots	Code
3.3 V	5 A	16.5 W	1	H
5 V	5 A	25 W	1	J
12 V	4 A	48 W	1	L

Note: For configurations, refer to page 4.

Summary

Characteristic	Minimum	Typical	Maximum	Units	Notes & Conditions
Input Range	85	115 / 230	264	VAC	Universal input range.
Input Frequency	47	50 / 60	63	Hz	AC input.
Efficiency		91	92	%	At input 230VAC, rated load, 1.0 hr. warm up.
Operation Temperature	-20		+70	°C	Derate linearly from 50°C, become 50% load at 70°C.
Weight		1581.8		g	
Dimensions	229 (L) x 127 (W) x 65 (H) mm, Tolerance +/- 0.5mm.				
EMC	EN 55011, EN 60601-1-2, EN 61000-3-2, EN 61000-3-3, IEC 61000-4-2, IEC 61000-4-3, IEC 61000-4-4, IEC 61000-4-5, IEC 61000-4-6, IEC 61000-4-8, IEC 61000-4-11				
Safety	IEC 60601-1, EN 60601-1, ANSI / AAMI ES60601-1:2005, CAN / CSA-C22.2 No. 60601-1:08				

Input

Characteristic	Minimum	Typical	Maximum	Units	Notes & Conditions
Input Voltage	85	115 / 230	264	VAC	Universal input range.
Input Frequency	47	50 / 60	63	Hz	AC input.
Input Current	4		12.5	A	Nominal AC Input Voltage (115VAC/230VAC), rated load.
Inrush Current			30 / 60	A	Nominal AC Input Voltage (115VAC/230VAC), one cycle at 25°C cold start.
Patient Leakage Current		100 / 300		μ A	Normal Condition / Single Fault Condition.
Power Factor		0.92			Rated load @ 230 VAC
Input Protection	Dual non-user serviceable internally located AC input line fuse. Fuse : 15A / 250VAC * 2pcs				

Output

Characteristic	Minimum	Typical	Maximum	Units	Notes & Conditions
Output Voltage		24(V1)		VDC	
		5.1(V2)			
		-12(V3)			
Initial Set Accuracy		± 1		%	Initial setting accuracy is adjusted at input 115VAC and output at 60% rated load.
Minimum Load		0		A	
Start Up Delay		2.5 / 1.0		Sec.	Time required for initial output voltage stabilization. Nominal AC Input Voltage (115VAC/230VAC), rated load at 25°C.
Hold Up Time	16	20		mS	Nominal AC Input Voltage (115VAC/230VAC), rated load.
Line Regulation		$\pm 1^{(V1)}$ $\pm 1^{(V2)}$ $\pm 1^{(V3)}$		%	Less than $\pm 1\%$ at rated load with $\pm 10\%$ changing in input voltage.
Load Regulation		$\pm 1^{(V1)}$ $\pm 4^{(V2)}$ $\pm 10^{(V3)}$		%	Measured from 60% to 100% rated load and from 60% to 20% rated load (60% $\pm 40\%$ rated load).
Ripple & Noise		240 ^(V1) 100 ^(V2) 120 ^(V3)		mV	Measured at rated load by a 20MHz bandwidth limited oscilloscope and each output is connected with a 10 μ F Electrolytic Capacitor and a 0.1 μ F Ceramic Capacitor.
Overvoltage Protection	For some reason the power supply fails to control itself, the build-in over voltage protection circuit will shut down the outputs to prevent damaging external circuits.				
Overload Protection	Auto recovery.				
Short Circuit Protection	Fully protected against output overload and short circuit. Automatic recovery upon of overload condition.				
Remote On / Off	The power supply will be turned on when the power On/Off pin is connected to secondary GND.				

General

Characteristic	Minimum	Typical	Maximum	Units	Notes & Conditions
Efficiency		91	92	%	At input 230VAC, rated load, 1.0 hr. warm up.
Isolation	IP to OP	4000		VAC	2 x MOPP
	IP to Ground	1500		VAC	1 x MOPP (Screw head to primary)
Switching Frequency		91		KHZ	
MTBF		142100		hrs.	MIL-HDBK-217F at 25°C
Power Good Signal	When power is turned on, the power good signal will go high 100 mS to 500 mS after all output DC voltages are within regulation limits.				
Power Fail Signal	The power fail signal will go low at least 1 mS before any of the output voltages fall below the output drop to 95%.				

Environmental

Characteristic	Minimum	Typical	Maximum	Units	Notes & Conditions
Low temperature start up	-20			°C	Some specification parameters maybe exceeded until after 20 minutes warm up period.
Operating Temperature	-20	50	+70	°C	Derate linearly above 50°C, performance curves will be provided after testing.
Storage Temperature	-40		+85	°C	
Relative Humidity	5		95	%RH	Non-condensing.
Operating Altitude		5000		m	
Vibration	0.26		6.09	G	Frequency Type: Sweep Frequency Frequency Range: 10~55 Hz Displacement: 1.0mm Sweep Rate: 60 minute / cycle Number of cycle: 1 cycle / axis Direction: X ,Y and Z axis

Model no. coding

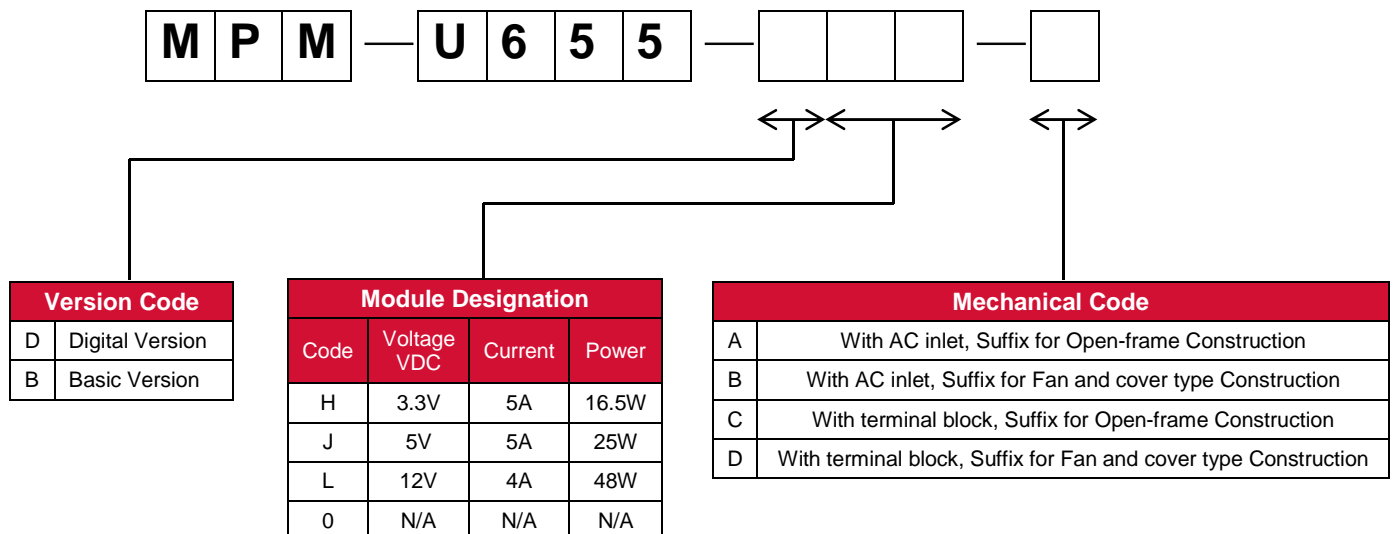

Derating curve

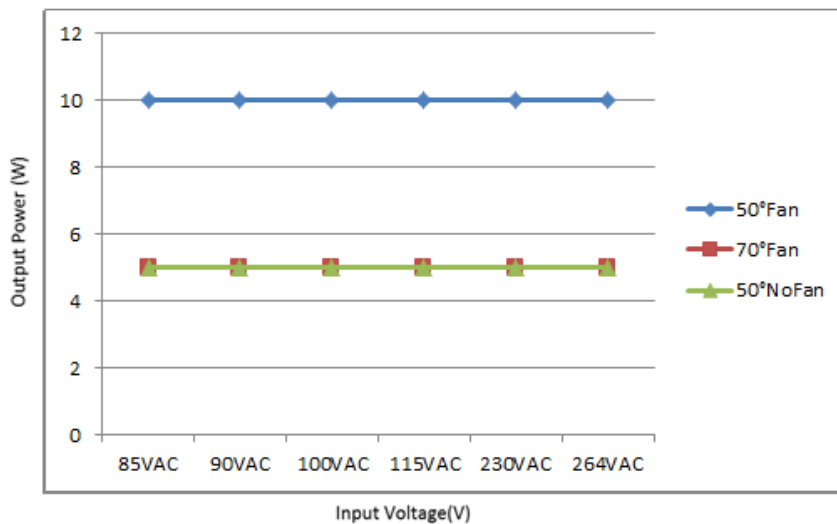
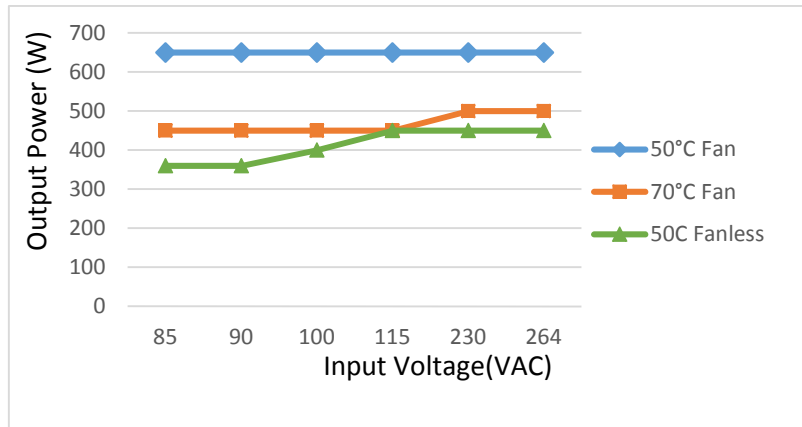

5VSB

Performance curves of MPM-U655

EMC: Emissions

Phenomenon	Standard	Class	Notes & Conditions
Conducted	EN 55011 / CISPR 11 & FCC Part 18	B	Pass with a metal plate below the power supply and output load.
Radiated	EN 55011 / CISPR 11 & FCC Part 18	B	
Harmonic Current	EN 61000-3-2	D	
Voltage Flicker	EN 61000-3-3		

- Note:
- Above specification is applied with output equal or below 650W. For higher output power, please re-confirm with us.
 - Above specification is based on the test conditions of EN 55011 / CISPR 11 & FCC Part 18. If there is any question when the power supply is applied to the system, please contact us for assistance.

EMC: Immunity

Phenomenon	Standard	Criteria	Notes & Conditions
ESD	IEC 61000-4-2	A	±15KV air discharge, ±8KV contact discharge
Radiated	IEC 61000-4-3	A	10V/m
EFT	IEC 61000-4-4	A	±2KV Line & PE, 100KHz
Surges	IEC 61000-4-5	A	L-N:±1KV, L/N-PE:±2KV
Conducted	IEC 61000-4-6	A	10V
Power Magnetic	IEC 61000-4-8	A	30A/m
Dips and Interruptions	IEC 61000-4-11	A A A / B B	DIP: 100%, 0.5 cycle DIP: 100%, 1 cycle DIP: 30%, 25 cycles (Note 2) DIP: 100%, 5 Sec

Note:

- Above specification is applied with output equal or below 650W. For higher output power, please re-confirm with us.
- The test result of input 240Vac / 100Vac is criteria A / B.

Safety Approvals

Safety Agency	Safety Standard	Notes & Conditions
TUV	EN 60601-1: 2006+A11+A1+A12	Designed to meet (Medical 3.1 rd)
CB	IEC 60601-1: 2005+CORR. 1: 2006+CORR. 2: 2007+A1: 2012	
UL/cUL	ANSI/AAMI ES60601-1, CAN/CSA-C22. 2 No. 60601-1	Designed to meet (Medical 3.1 rd)

Digital Interface

Item	Content
Device class	Mini-USB Type B 12Mbps USB 2.0 Full-Speed, USB CDC class (RS232 Type)
CDC Baud rate	19200 bit/s
Protocol	Magic Power Standard protocol
Output Real-Time Item (Note 1)	Output Voltage Output Current Output Power Remote Signal PGPF Signal OTP Signal
Output Information Item (Note 1)	Model Name Firmware Version Rate Voltage Rate Power

Note:

- Customer can control the PSU ON / OFF and read above output data through the mini USB device with a PC.
- If any other control / read function is needed, please contact Magic Power to check the modification.

Mechanical Details

MPM-U655-DXX-A: With AC inlet, ("A" Suffix for Open-frame Construction) Dimensions 229 (L) x 127 (W) x 65 (H) mm.

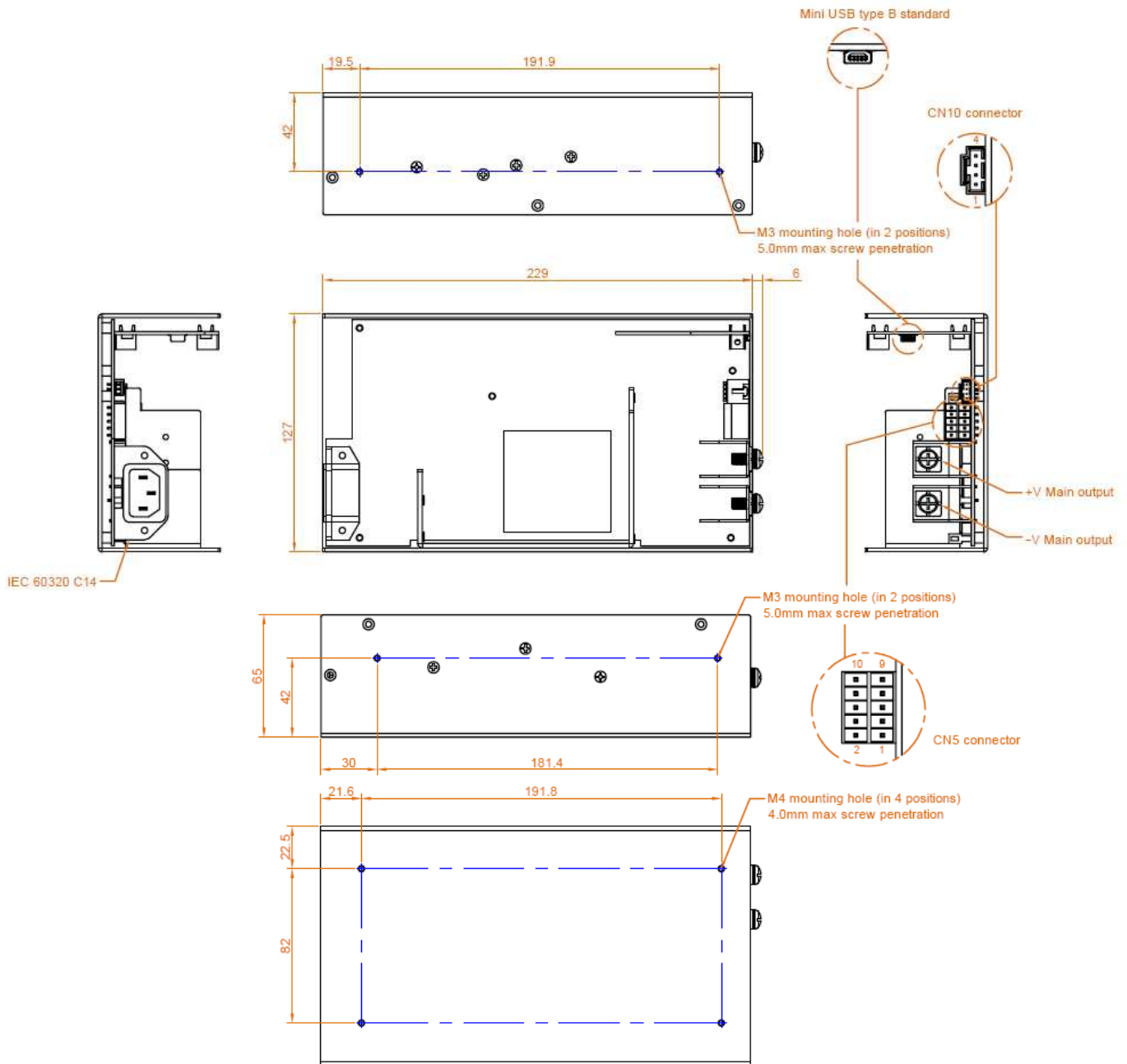

Signal connector CN10	
Pin	Function
1	0V
2	+5VsB
3	PG/PF
4	Remote on/off

Mates with Molex 70430-0143

Signal connector CN5			
Pin	Function	Pin	Function
6	0V	1	+V4 (Optional)
7	0V	2	+V4 (Optional)
8	0V	3	+V5 (Optional)
9	0V	4	+V5 (Optional)
10	0V	5	-12V

*Optional (+V4 CN4, +V5 CN3)

Mates with Dinkle 0159-0310

Note: 1. Optional daughter board for the digital function to read PSU data by mini USB type B connector and Magic Power software installed.
2. If MPM-U655-BXX-A, remove "Mini USB type B standard".

MPM-U655-DXX-B: With AC inlet, ("B" Suffix for Fan and cover type Construction) Dimensions 229 (L) x 127 (W) x 65 (H) mm.

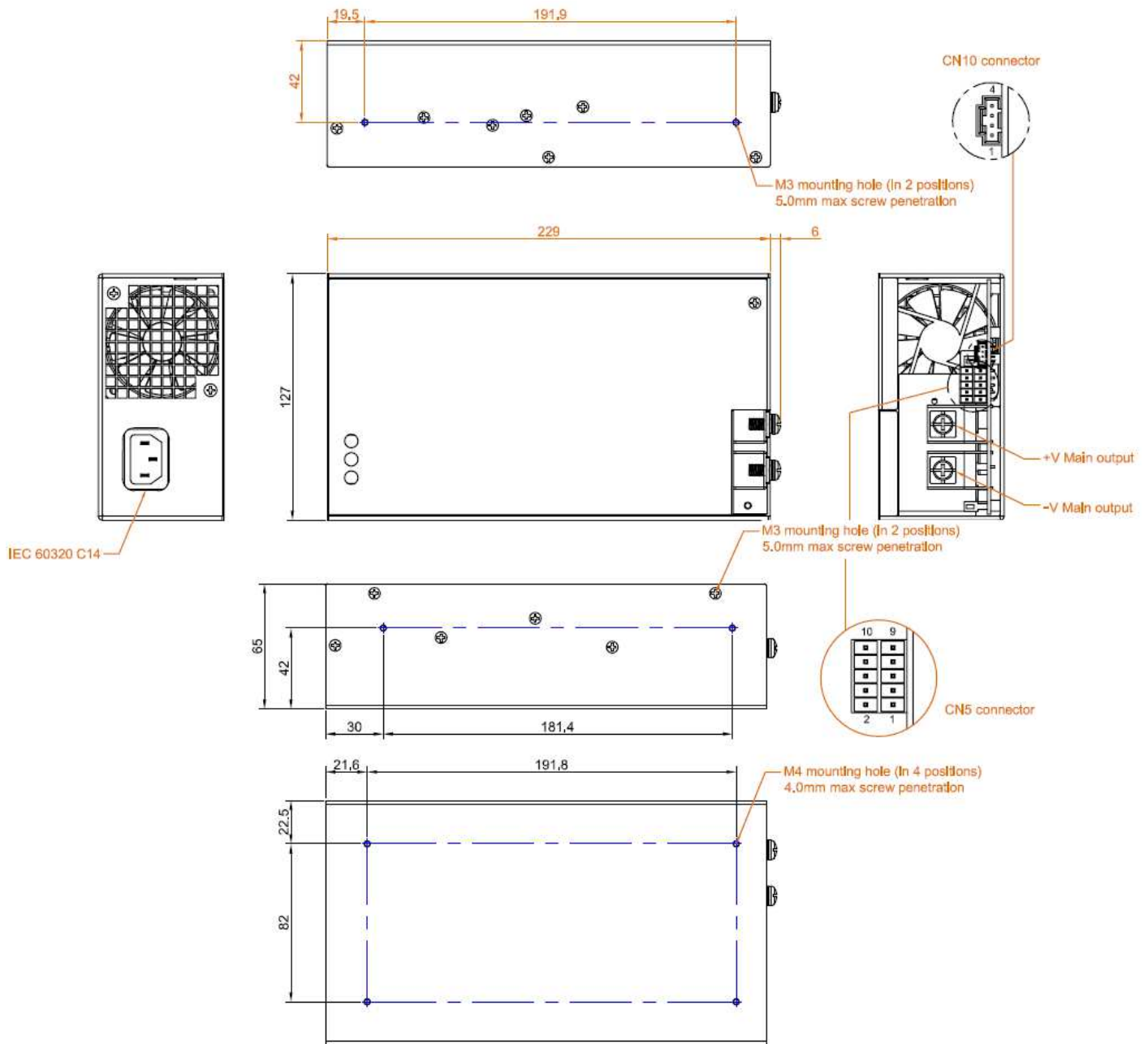

Signal connector CN10	
Pin	Function
1	0V
2	+5VsB
3	PG/PF
4	Remote on/off

Mates with Molex 70430-0143

Signal connector CN5			
Pin	Function	Pin	Function
6	0V	1	+V4 (Optional)
7	0V	2	+V4 (Optional)
8	0V	3	+V5 (Optional)
9	0V	4	+V5 (Optional)
10	0V	5	-12V

*Optional (+V4 CN4, +V5 CN3)

Mates with Dinkle 0159-0310

Note: Optional daughter board for the digital function to read PSU data by mini USB type B connector and Magic Power software installed.

MPM-U655-DXX-C: With terminal block, ("C" Suffix for Open-frame Construction) Dimensions 229 (L) x 127 (W) x 65 (H) mm.

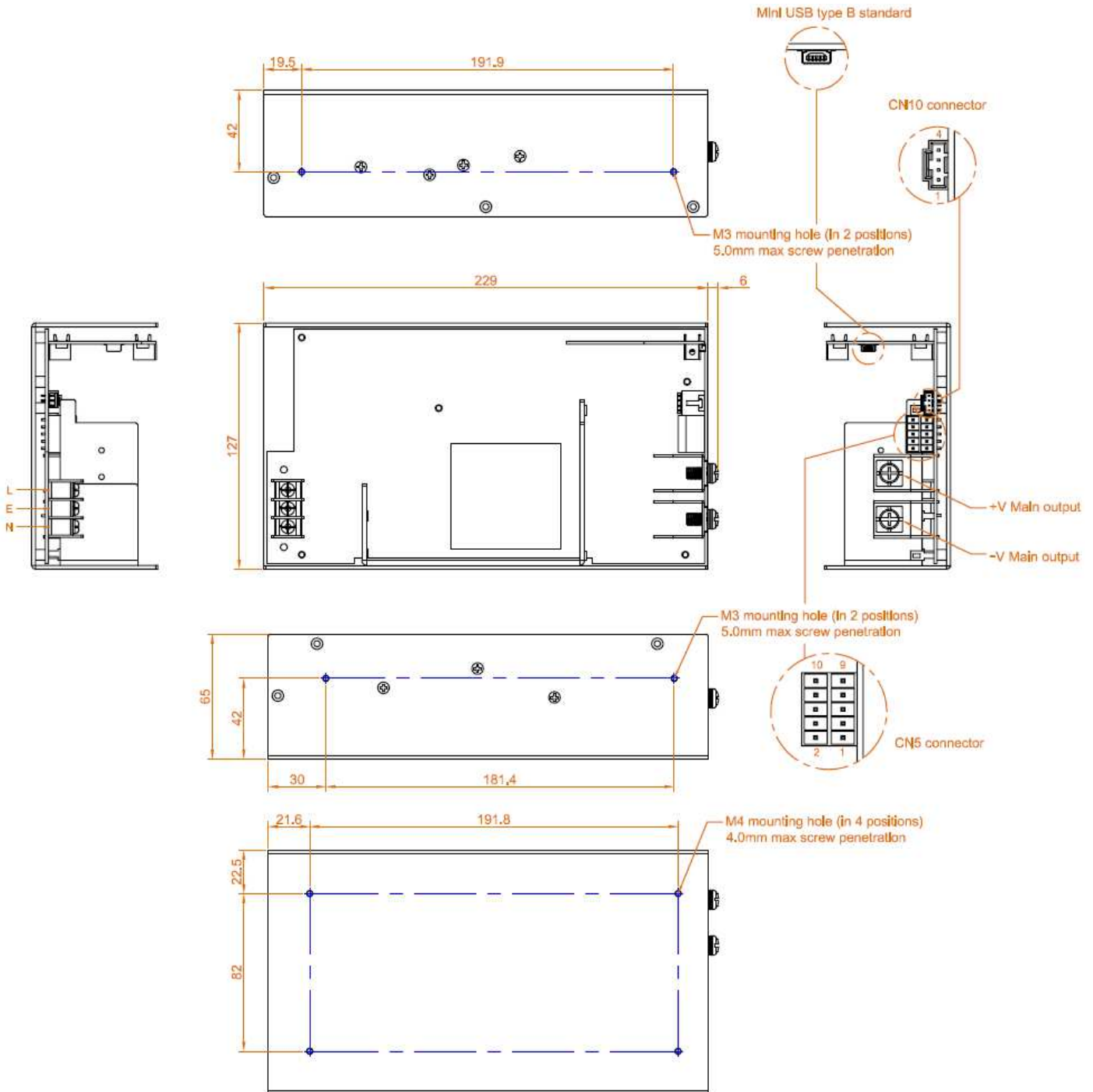

Signal connector CN10	
Pin	Function
1	0V
2	+5VsB
3	PG/PF
4	Remote on/off

Mates with Molex 70430-0143

Signal connector CN5			
Pin	Function	Pin	Function
6	0V	1	+V4 (Optional)
7	0V	2	+V4 (Optional)
8	0V	3	+V5 (Optional)
9	0V	4	+V5 (Optional)
10	0V	5	-12V

*Optional (+V4 CN4,+V5 CN3)

Mates with Dinkle 0159-0310

Note: 1. Optional daughter board for the digital function to read PSU data by mini USB type B connector and Magic Power software installed.
2. If MPM-U655-BXX-C, remove "Mini USB type B standard".

MPM-U655

650W Medical AC / DC

MPM-U655-DXX-D: With terminal block, ("-D" Suffix for Fan and cover type Construction) Dimensions 229 (L) x 127 (W) x 65 (H) mm.

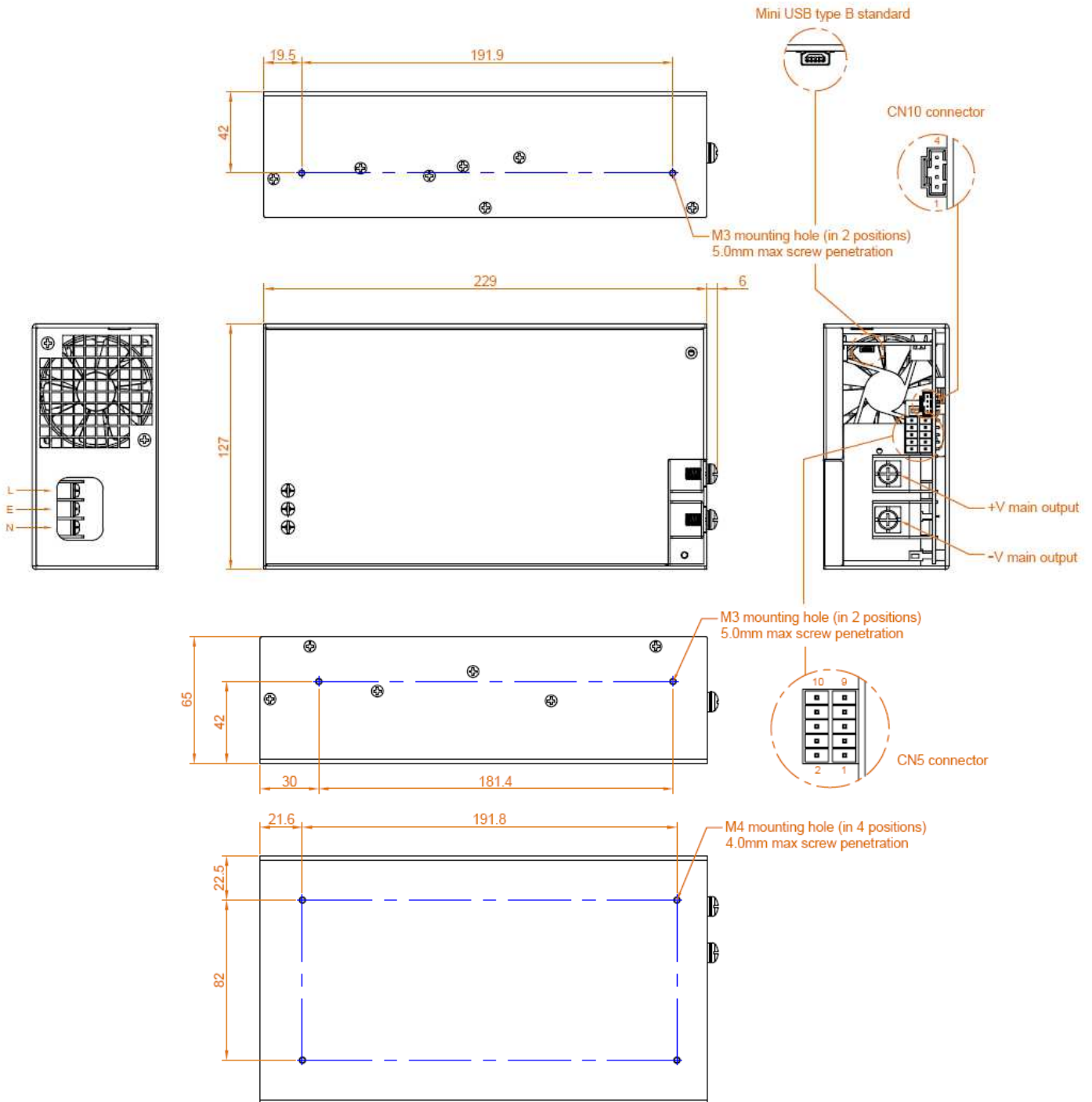

Signal connector CN10	
Pin	Function
1	0V
2	+5VsB
3	PG/PF
4	Remote on/off

Mates with Molex 70430-0143

Signal connector CN5			
Pin	Function	Pin	Function
6	0V	1	+V4 (Optional)
7	0V	2	+V4 (Optional)
8	0V	3	+V5 (Optional)
9	0V	4	+V5 (Optional)
10	0V	5	-12V

*Optional (+V4 CN4, +V5 CN3)

Mates with Dinkle 0159-0310

Note: 1. Optional daughter board for the digital function to read PSU data by mini USB type B connector and Magic Power software installed.
2. If MPM-U655-BXX-D, remove "Mini USB type B standard".

Performance

(Input voltage: 115Vac)

Switching frequency ripple rated load



20mV/div, 5uS/div

Line frequency ripple rated load

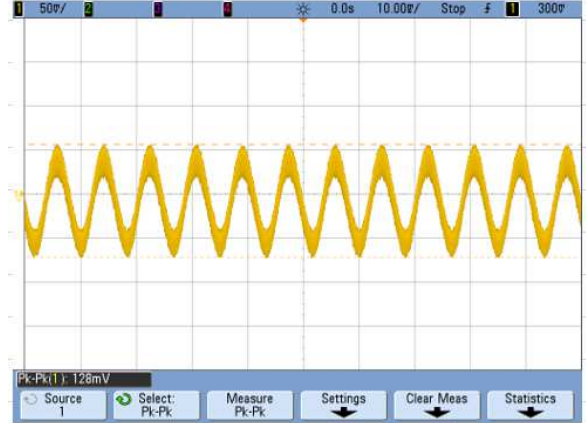

50mV/div, 10mS/div

Output turn-on rated load



10V/div, 50mS/div

Output turn-off rated load



10V/div, 50mS/div

Hold-up time rated load

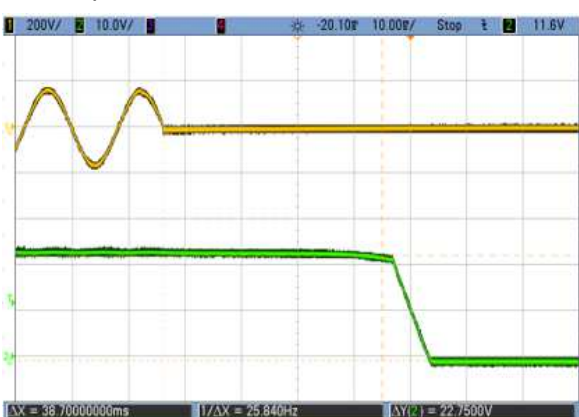

200V/div, 10V/div, 10mS/div

OVP 60% of rated load



10V/div, 20mS/div

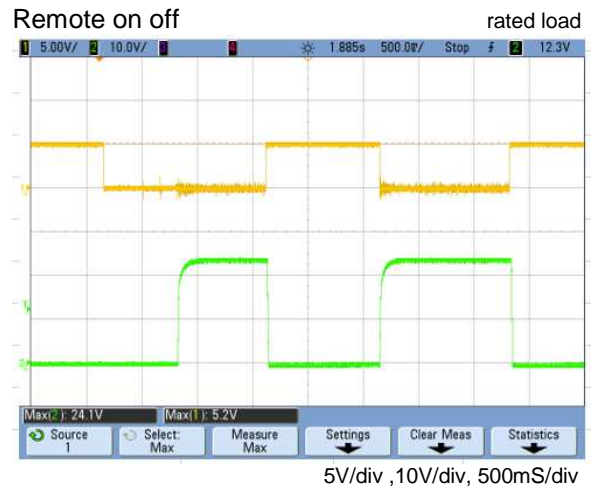
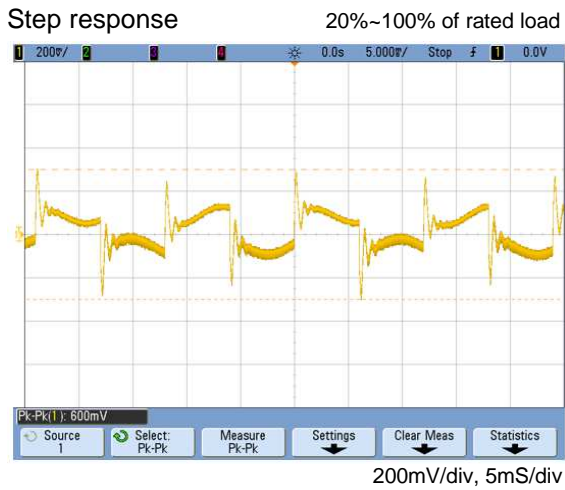
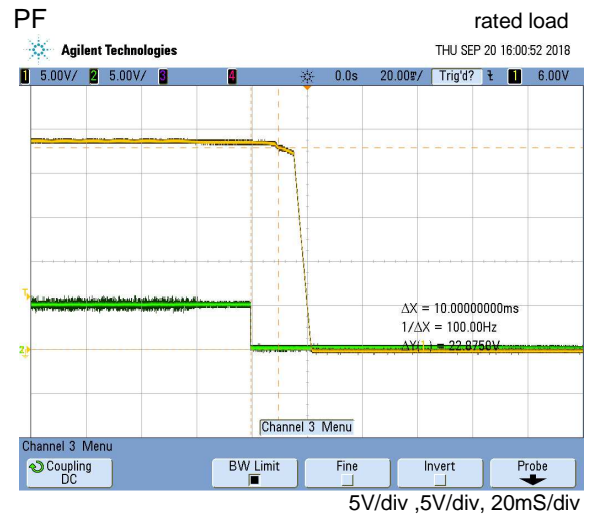
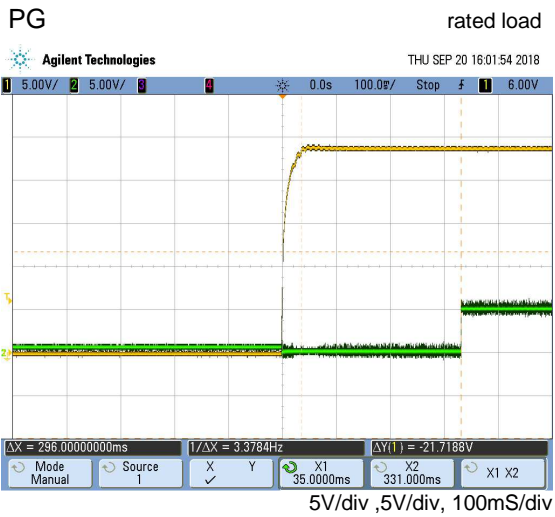

EMI: EN55011 "B" (Conduction)

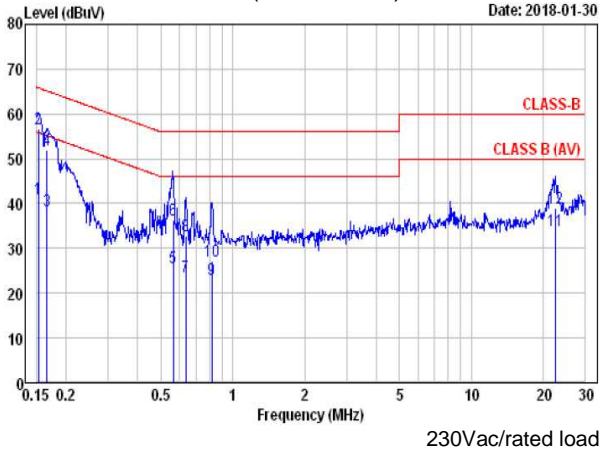

EMI: FCC "B" (Conduction)

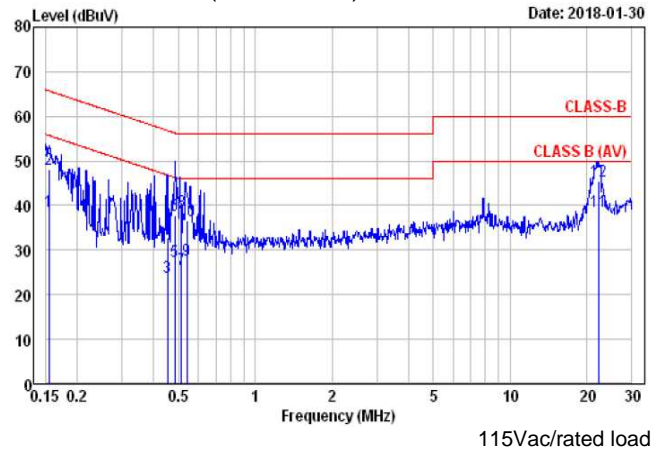

EMI: EN55011 "B" (Radiation)

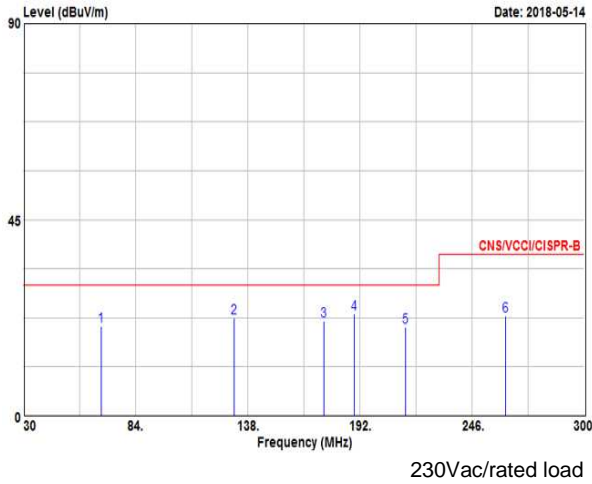

EMI: FCC "B" (Radiation)

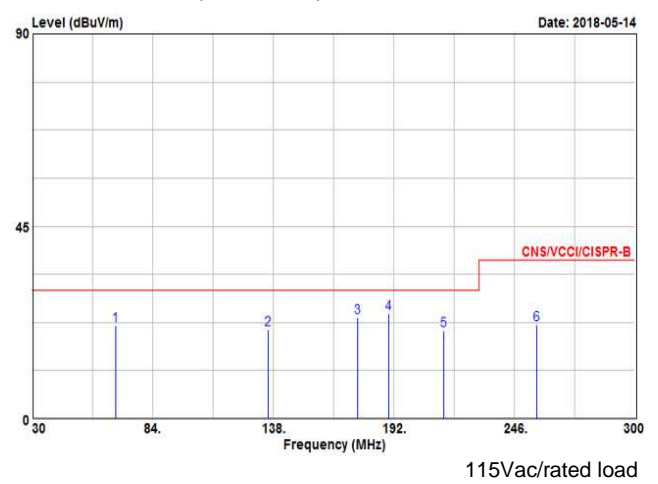

Thermal Considerations

In order to ensure safe operation of the SPS in the end-use equipment, the temperature of the components listed in the table below must not be exceeded.

Temperature should be monitored using J type thermocouples placed on the hottest part of the component (out of any direct air flow). See mechanical details for component locations.

Temperature measurements at max. amb.	
Component	Max Temperature
T1	120°C
Q2	130°C
Q6,Q6A,Q7,Q7A	130°C
C3,C3A,C3B,C3C	105°C
C11,C11A,C11B,C11C	105°C